

UltraSecure 3000 with UltraSmart Owners Manual

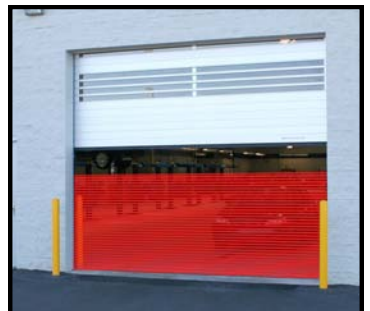

STATEMENT OF WARRANTY

UltraSecure 3000 High Speed Doors

ONE-YEAR WARRANTY ON MECHANICAL AND ELECTRICAL COMPONENTS

- **Albany Door Systems** warrants to the original owner of the door that the mechanical and electrical components will be free from defects in material and workmanship for a period of **one (1) year** from the date of shipment. The warranty does not cover fuses, heat lamp elements, bulbs, and seals.
- Only defects brought to the attention of **Albany Door Systems** during the warranty period will be covered by this warranty.
- **Albany Door Systems** will replace component parts covered by this warranty, which are found to be defective upon inspection by an **Albany Door Systems** representative. Installation or use of parts other than those authorized by **Albany Door Systems** will void this warranty.
- PARTS AND ASSEMBLIES sold separately by **Albany Door Systems** that fail due to defects in material or workmanship within **ninety (90) days** from the date of shipment will be replaced under warranty provided installation has been carried out in accordance with all **Albany Door Systems** procedures. This warranty is limited to providing a replacement part only. This warranty does not cover freight, special charges, or any costs associated with the installation of the replacement part.
- This warranty covers material failure under normal wear conditions; it does not cover damage caused by collision or other abuse of the product. Adjustments made to the control panel or to the mechanical operation of the door without the authorization of **Albany Door Systems** will void this warranty. Any changes made to product configuration without the express written approval from Albany Door Systems may null and void this warranty.
- **Albany Door Systems'** obligations under this warranty are limited to repairing or replacing the defective part including labor and **Albany Door Systems** shall not be responsible for any other losses or damages due to the operation of any door or parts covered by this warranty. Warranty parts will be shipped regular ground freight at the expense of Albany Door Systems.
- This warranty shall be void in its entirety if the failure of any product shall be caused by any installation, operation, or maintenance of the product which does not conform with the requirements set forth by the seller in the applicable product manuals or is in the result of any cause other than a defect in the material or workmanship of the product.
- No other oral or written representations made by **Albany Door Systems** or its agents are a part of this warranty unless specifically set forth in writing by an authorized **Albany Door Systems** official.

THE ABOVE SET FORTH WARRANTY IS SELLER'S SOLE WARRANTY. SELLER MAKES NO OTHER WARRANTY OF ANY KIND WHATSOEVER, EXPRESSED OR IMPLIED; AND ALL IMPLIED WARRANTIES OF MERCHANTABILITY AND FITNESS FOR A PARTICULAR PURPOSE WHICH EXCEED THE AFORESTATED OBLIGATION ARE HEREBY DISCLAIMED BY SELLER AND EXCLUDED FROM THIS AGREEMENT

WARNING

Do not install, operate or service the product unless you have read and understand the safety practices, warnings, installation and maintenance instructions contained in this manual.

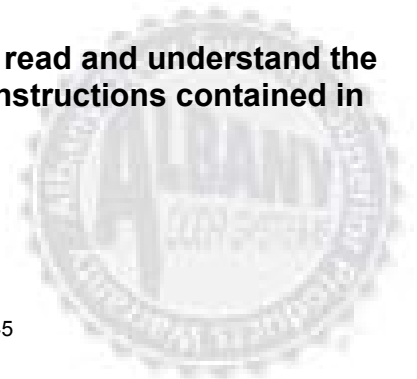

TABLE OF CONTENTS

Introduction 3

Product Description 4

Drawings 7

Inspection Plan 9

Safety Instructions 12

Troubleshooting 14

Maintenance 15

UltraSmart Control 17

Wiring 25

Wireless Safety System 31

UltraSmart Startup Procedure 32

Parts Diagram 37

ALBANY DOOR SYSTEMS CONTACT INFORMATION:

Port Washington, WI

1080 Maritime Drive, Port Washington, WI 53074
Phone: 262-268-9885 Fax: 262-268-9895 Technical Support: 262-268-9885
www.albanydoors.com / support@albint.com

Lawrenceville, GA

945 A Old Norcross Road, Lawrenceville, GA 30045
Phone: 800-252-2691 Fax: 262-268-9895 Technical Support: 262-268-9885
www.albanydoors.com / support@albanydoors.com

INTRODUCTION

The contents of this manual are designed to help you operate and maintain Albany UltraLite™, UltraFast™, UltraCool™, and UltraFreeze™ high speed doors.

DO NOT operate or perform maintenance on the high speed door unless you have read through the instructions in this manual.



The safety alert symbol is used to identify safety information about hazards that can result in personal injury. A signal word (DANGER, WARNING, or CAUTION) is used with the safety alert symbol to indicate the likelihood and the potential severity of injury. In addition, a hazard symbol may be used to represent the type of hazard.



DANGER indicates a hazard that, if not avoided, will result in death or serious injury.



WARNING indicates a hazard that, if not avoided, could result in death or serious injury.



CAUTION indicates a hazard that, if not avoided, might result in minor or moderate injury.



CAUTION, when used without the alert symbol, indicates a situation that could result in damage to the door.



NOTICE is used to inform you of a method, reference, or procedure that could assist with specific operations or procedures.

Other symbols that may be used in this manual are:



Lock Out / Tag Out



Crushing



Fire



Shock



Read Manual

Product Description

Principle

The UltraSecure 3000 is a vertically opening high-speed rolling metal door primarily for external use. The door panel is made of aluminum slats connected to a special belt. The slats wind on up to three variable sized disc modules. They do not stack or wind onto each other, which protects the slats from excessive wear and produces smooth, contact-free frictionless operation that allows for the high opening speed.

Absorbing profiles attached to the perimeter of the discs enables quiet operation and dampen vibration of the slats during winding.

The flat belt functions as a pulling device. Hinges and rollers are not necessary in this door system, allowing for longer maintenance intervals and increased door life. Rubber connections between each slat prevent moisture from entering and from settling between the slats.

The pulling power is transferred equally to the disc modules by a gear motor via a drive shaft. This is also supported by tensioned springs located within the side columns. The door closes with assistance from the weight of the panel.

The panel moves vertically within special guide rails located in the side frames.

The door may be opened manually in the event of a power outage by releasing the brake via the side column mounted egress lever.

The UltraSecure 3000 is equipped with a wireless electric reversing edge and inline safety light curtain photo eyes..

Slats

The slats of the Rapid Roll 3000 are double walled extruded anodized aluminum with rubber seals in between. Each slat is individually connected and can be easily removed and replaced.

Window slats are available as an option.

Side Frame

The side frames and cross sections of the Rapid Roll 3000 are galvanized steel.

The various elements of the side frames come pre-assembled from the manufacturer.

During installation, the side frames must first be set up and fastened to the wall / floor in the upper and lower area. The upper width gauge can help define the exact distance of the side frames.

After the side frames have been secured to the wall, the pre-assembled top roll with the rolled-up door panel must be placed onto the top of the side frames and secured.

Control Unit

The UltraSecure 3000 is operated by a frequency converter control unit, which enables smooth acceleration and deceleration of the door. The maximum opening speed is 80 in/sec depending on door size. The door's closing speed is approximately 24 in/sec.

Manual Operation

During maintenance work, or in the event of a power outage, the door may be opened manually by releasing the brake via the side column mounted egress lever. The door opens partly by itself after the brake is released, and may be opened further by manually pushing the door panel upwards.

Electric Safety Devices

The door is equipped with various safety devices, which are partly based on radio – photocell systems.

Electric safety features

The UltraSecure door utilizes a minimum of two safety features. This is comprised of safety photocells and electric reversing edge.

Self-monitoring Drive Unit

The temperature of the drive unit is regulated by a thermal switch, which disrupts the power supply of the drive unit upon overheating.

Testing the Safety Systems

Before each downward movement an internal “self-testing” of the photocells and the control unit is made automatically (Safety classification 2 according DIN EN 954-1 "Safety relevant parts of control units"). If a fault is detected, disruption of the power supply to the control unit occurs immediately. The safety switches work as a closing unit and are in continuous operation.

Additional Safety Systems

Depending on the kind of application it may be advisable to utilize additional sensors for safety reasons. This will be especially valid for doors with frequent pedestrian traffic or doors less than 10 feet high due to limited optical awareness of a closing door by the user. Albany Door Systems offers various additional safety systems for fast running doors such as; motion sensing detectors, floor loops, etc. We suggest individual consultation with an Albany Door Systems' representative at the application site .

Mechanical Safety Devices

Springs are situated in separate chambers serving as a weight balancing system. The springs are enclosed and protected by metal covers.

The door has a multi independent weight balancing system. Disengagement of the drive unit brake will not lead to a sudden drop of the door panel.

NOTICE

For doors with a height less than 8 feet a top roll cover is absolutely necessary according to valid regulations.

Drive Unit

An electric drive unit operates the UltraSecure 3000. The drive unit is installed in the upper area of the door, not within reach from the floor, and has a vibration dampening attachment. The drive unit may be positioned on either the left or right hand side, according to customer requirements.

The same drive is used for all varieties of door height. The frequency converter control unit will be operable with various parameters depending on the size of the door.

CAUTION

The door may only be operated with an original drive and control unit made by the manufacturer of the door.

Technical Data

Door principle:	rolling metal
Running direction:	vertical
Application:	fast running exterior (primarily) or interior
Available sizes:	W min.: 2.58 ft (1250mm) W max.: 16.4 ft (5000mm) H min.: 6.50 ft (2500mm) H max.: 16.4 ft (5000mm) Height steps: 1/2 inch (125mm)
Max. opening speed:	80"per sec (2.5 m/s)
Closing speed:	approx. 24"per sec (0.7 m/s)
Application:	inner side of exterior wall
Drive:	electric
Connecting voltage:	3/(N)/PE 230/400 V \pm 10%, 50/60 Hz
Motor performance:	1.1 kW
Control unit:	UltraSmart Control (frequency converter control unit)
Control voltage:	24 V DC
Motor protection:	IP55
Side frame:	galvanized steel
Door curtain:	double walled anodized aluminum
Pulling device:	flat belt with integrated steel ropes
Sound pressure level:	70 dB A
Wind resistance:	110 m/h, classification 3 (EN 12424)
Door measurements and installation space:	see enclosed drawing

Fixing points: see enclosed fixing point plan

NOTICE

Technical changes to the door and the manual can occur. If you have questions please consult with the factory.

UltraSecure 3000 10' high up to 16' high

UltraSecure 3000 up to 10' high

Inspection Plan	
Observe the safety notices within the operation manual. Power to the door must be shut off during inspection of any door component.	
Installation fixings	
spring housing and eventually the existing top roll and motor cover must be dismantled.	Annually or 100,000 cycles.
Drive unit	
Check retainer of the torque support and buffer.	Annually or 100,000 cycles.
Check function of brake release lever.	Annually or 100,000 cycles.
Check self-opening/manual opening/egress	Annually or 100,000 cycles.
Drive shaft	
Check flange bearing retainers of drive shaft.	Annually or 100,000 cycles.
Check retainer of the spiral disk on the shaft.	Annually or 100,000 cycles.
Check condition of sound isolation or black dampener profiles on the spiral disk.	Annually or 100,000 cycles.
Exchange of flat lifting belts.	500,000 cycles.
Door leaf	
Check surface of lamellas/slats for grinding and signs of damages.	Annually or 100,000 cycles.
Check exact position of lamella sealing.	Annually or 100,000 cycles.
Check fixing of lamellas on pulling device.	Annually or 100,000 cycles.
Check solid position of lamella adapter/endplates.	Annually or 100,000 cycles.
Guiding rails	
Check for wear and tear on guiding rails, especially in the area of funnels (if equipped).	Annually or 100,000 cycles.
Side columns and lintel profile	
Check fixing and condition of the profiles as well as fixing at the wall.	Annually or 100,000 cycles.
Check condition and fixing of trailing chain for cable if equipped	Annually or 100,000 cycles.
Check condition and installation of springs and spring fixing.	Annually or 100,000 cycles.
Check leaf tensioning system if equipped.	Annually or 100,000 cycles.
Exchange rubber cable/bungee cord if equipped	500,000 cycles.
Clean optic of photocells.	As necessary.
Counter balance system	
Exchange springs $H < 3m$.	500,000 cycles.
Exchange springs $H \geq 3m$.	250,000 cycles.
Check condition and fixing of the spring belts.	Annually or 100,000 cycles.
Lubrication of roller chain (only RR3000R).	Annually or 100,000 cycles.
Control Box and additional components (like safeties & actuators)	
Check completeness of wiring diagram.	Annually
Check main switch/CEE-plug and control box lock.	Annually
Check fixing of control panel	Annually
Check function of stationary and/or pre-running photocells	Every 6 months or 25,000 cycles.
Verify stopping position of limits	Annually or 50,000 cycles.
Check function of electric reversing edge if equipped	Every 6 months or 25,000 cycles.

Safety Instructions

Area of Application and Classified Use

Unless explicitly described otherwise, Albany Door Systems' doors are developed and tested for use under normal operating conditions. For an application with special conditions (for example; one-sided permanent load with temperatures, excessive pressure or special environmental conditions, etc.) contact Albany Door Systems.

The door is defined primarily for use in industrial buildings.

As an exterior door with respective resistance against wind pressure and weather conditions it opens with a speed especially suited for high frequency vehicular traffic ensuring a smooth transport flow.

The door may also be applied as an interior door.

Duty of Care

The door has been designed and manufactured under consideration of a risk analysis according careful selection of valid norms and further technical specifications. The system meets status of technique and ensures the highest level of safety.

All necessary measures and precautions must be observed in order to achieve the high safety standard. It is the duty of the door operator to plan the respective measures and check the door's performance. Please read the user manual carefully and keep it in a safe place for future use.

The operator is liable to ensure that:

- Installation, initial operation, inspection, maintenance, repair work and dismantling are made only by manufacturer personnel or manufacturer trained and qualified personnel.
- Only sufficiently trained, qualified and authorized personnel should operate the door system.
- The door is to be used only in accordance with the classified purpose (see above).
- The door is to be operated only in a perfectly functioning state and that the safety features are regularly checked for orderly operation.
- The user manual is kept at the site of the door for future use and is in readable condition at all times.
- The operating personnel are continuously trained with regard to working safety and operating instructions and especially the herein-contained safety instructions.
- All safety and caution notices affixed to the door will not be removed and are kept in readable condition.

General Safety Advice

- Please read the user manual carefully and keep it easily accessible for future use.
- Always follow the safety instructions mentioned in the user manual.
- Do not use this door for purposes it is not intended for. This user manual must also be transferred upon the transfer of this door to third parties.
- The use of the emergency lever may lead to a partial self-opening or closing of the door.
- The door panel may be opened upon failure of the electrical drive by disconnecting the brake using the emergency disconnect lever.
- Do not put your hands on the side frames of the door during operation.
- Lingering of persons in the working area of the door should be avoided. Existing man doors should be used for pedestrian traffic.
- Should it be necessary for pedestrians to utilize the door opening, they should walk through at a normal pace.
- Keep the immediate area of the door free of debris or refuse, which could cause accidents.
- Do not climb on the door.
- The power to the door must be shut off at the main switch and must be secured against returning to the “on” position prior to working on the door.
- Upon damage to the door (mechanical or electrical), the power must immediately be turned off. This is especially valid when damage has occurred to the electrical cables or wiring.
- The door must only be operated within the parameters of the defined voltage or net frequency.
- Use only equipment or additional features which are authorized by the manufacturer of the door.
- Operating the door during excessive wind pressures may be dangerous.

Safety instructions must be observed without exception, not only the general safety instructions but also the special notices mentioned in other chapters of the manual

Additional Advise

Please call 800-252-2691 for further information about this product or about Albany Door Systems' complete product line.

Troubleshooting

To avoid damage to the door or injury to personnel during repair of malfunctions or errors, the following instructions should be carefully observed:

- Only trained personnel should accomplish Work.
- Turn off the power at the main switch prior to performing any work.
- Secure the main switch against being turned on again by locking it or by having a second person present.
- Secure the door's operating area.
- Read "Safety Instructions".

In the event the repair cannot be made or assistance is required, please contact the customer service department of the supplier or manufacturer of the door.

Mechanical Malfunctions

Malfunction	Possible Causes	Necessary Measures
Door opens independently	Brake at the drive defective	Replace the brake
	Brake incorrectly adjusted	Adjust the brake
	Counterbalance is oversized	Call customer service
Manual opening not possible	Counterbalance defective	Replace the counterbalance device
	Bowden cable hanging off or too loose	Check correct position and tension of the bowden cable
	Brake blocking	Call customer service
Drive not functioning	Power supply is off	Connect the door to the power
	Electrical connections defective	Check electrical connections
	Safety device is defective	Replace the safety device
Curtain unwraps	Door not correctly installed	Call customer service
	An object was rolled up	Close the door and check for enclosed object

Electrical Malfunctions

For repair of electrical malfunctions see the error code manual at the appendix of the user manual instructions.

Malfunction	Possible Causes	Necessary Measures
Door not functioning	Power supply is off	Check power supply and fuse
	Safety device damaged	Check control unit and replace the fuse
	Main switch off	Turn (main switch) switch on
	Stop-circuit interrupted	Check stop circuit. Unused stop inputs must be bridged in accordance with the circuit diagram.
Door does not close	Up impulse permanently activated	Test impulse actuator
	Photocell interrupted or disconnected	Test safety devices
Door closes only with next impulse	Toggle circuit adjusted	Check adjusted control function

Warranty

The door is warranted against defects in material and workmanship for a period of two-years from the date of installation. The door's counterbalance springs are warranted for a period of two years or 200,000 cycles from the date of installation, whichever occurs first.

Maintenance

Customer Service

In the event maintenance or repair is required, please contact the supplier or the manufacturer of the door.

Albany Door Systems
 1080 Maritime Drive
 Port Washington, WI 53074
 Main Telephone: 800-252-2691
 Customer Service Telephone: 262-268-9885
 Customer Service Fax: 262-268-9895

Inspection and Maintenance



Maintenance and inspection work must only be performed by manufacturer trained authorized personnel.

Before beginning the above-mentioned work the power must be disconnected by turning off the main power switch and locking it. The control unit must be checked to determine there is no power to it with the appropriate device. All ladders, scaffoldings, or similarly used equipment should correspond with valid safety regulations.

The area around the door must be blocked for traffic. Any spilled lubricating oil, tools and other material should be removed from the floor when work has been completed.

The necessary intervals, check-ups and instructions for such work are documented in the "Inspection Schedule" (see Appendix).

Cleaning

Cleaning and Maintenance of the Panel



Do not use any glass cleansing liquids (contents may be corrosive)

- Never use score cleansers, scrapers, razor blades, spatulas, etc.
- Clean with warm water, a small dose of mild plastic cleanser and a soft cloth.

Cleaning and Maintenance of the Side Frame

Dust may be removed with a soft cloth. Harder dirt may be removed with water and general liquid cleanser.

Grease or oil on the metal surfaces may be removed with solvent containing cleanser.



Do not use a high-pressure cleaning machine.

Clean Door Area

The floor around the side frames may become dirty with lubricants, etc. following maintenance work. This must be removed quickly.

Tensioning the Panel

The door is furnished with a panel tension system. The bottom profile is pulled down on both sides by means of a rope. The ropes guard a secure run during closing of the door especially during heavy wind force.

UltraSmart Control Panel

Controls





Figure 1 Control Panel Key

Display: The display shows operation, functions and error codes of the door operation. It is also used when setting adjustments.

 This key pad opens the door and stops the delay timer from closing the door.

 This key pad stops the opening or closing of the door.

 This key pad closes the door and stops the delay timer.

 This key pad opens the door at a slower speed than normal door operation. The door will open as long as the key pad is pushed.

 This key pad closes the door at a slower speed than normal door operation. The door will close as long as the key pad is pushed.

 This key pad sets the time delay of the door closing once it has reached the selected open position in manual mode.

 This key pad sets the time delay of the door closing once it has reached the selected open position in automatic mode.

 This key pad resets error codes, holding it for five (5) seconds will enter the menu. This button is also used while in the program mode to leave the present level and return to the previous program level, or exit the program mode.

 This key pad is used to select menu options while in the program mode.

 This key pad scrolls up in the menu, or increases a setting value.

 This key pad scrolls down in the menu, or decreases a setting value.

Control Panel Display

The display on the front of the control panel shows two lines of information. The top line displays system status and the second line displays details of the function or specifics of errors.

Normal Operation

During startup the display will show the software version programmed into the control panel and whether or not the door is ready for normal operation. Once the software has booted the door is ready for operation, the top line will display “Door Ready” unless there is an error detected.

During normal operation the top line will display the current door status, with respect to movement or timers. “Door Ready” will be displayed while in standby mode, if no errors are present.

The second line on the display will show the activator name for the function, or the safety device that triggered an action. The activator can be a manual input signal from the light curtain or reversing edge, or a breakaway switch input.

There can be normal operation with the top line displaying “Door Ready” and the display second line showing a warning.

The “Open: Delay timer Active” display is shown when the door is open and a timer function is operating to delay the door from closing. A “Preventer” code may be displayed if a condition exists to prevent the door from closing such as a disruption of the light curtain or a door bottom edge breakaway. The timer is re-armed if a “Preventer” condition exists.

If any of the warnings shown on page six (6) except for “RevEdge Was Tripped” is displayed, please contact Albany Door Systems for diagnosis and repair. If the bottom line displays “RevEdge Was Tripped” it indicates that the door is open due to a reversing edge trip during the previous close cycle.



The diagram show on page six (6) shows examples of normal operation displays.

Operator Service

Changing the Door Closing Time Delay

In normal operation the Auto time delay selects the delay time before closing the door once it has reached the selected open position.

To increase the time that the door waits before closing:

- Press  the time delay will be displayed in seconds at a flashing cursor. If no key pad is pressed the controller will automatically return to normal operation after approximately four (4) seconds.
- Press the  or  to change the time delay in second intervals.

After four (4) seconds the display will return to normal operation and the time will be stored in memory. If the time is set to “00” with the Man 1 Close Delay the door will remain open until this activator is triggered.

Seating the Door in the Tracks

This function is not applicable for the UltraSecure door. Breakaway upon impact is not possible.

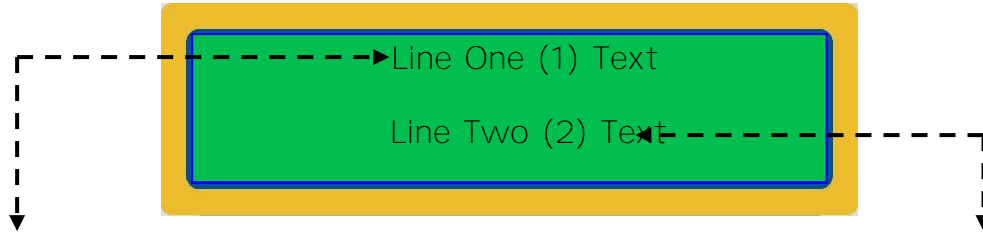

Startup:

R-Bac Industries
Door Not Ready

Normal Operation:

Door ready

Opening:

Opening — Full
Opening — Part

Open: Delay Timer Active

Auto1 Close Delay
Auto2 Close Delay
Man1 Close Delay
Man2 Close Delay
DTC Timer

Open Commanded :Delay Timer Active:

DTO Timer (Display shown during a count - down of the timer.)

Closing:

Closing

Normal: Warning

Door Ready

Startup:

Version n.m

Normal Operation:

000000 The zeros indicate the number of door operations. The counter will advance with each full or partial door opening. Version n.m (shown until first cycle)

Opening:

Auto 1
Auto 2
Man 1
Man 2
Open Pb
Open On Panel
Photo 1 (Front)
Photo 2 (Rear)
Reversing Edge
Breakaway

Open: Delay Timer Active:

(Preventer, if any)

Open Commanded :Delay Timer Active:

Closing:

Auto 1
Auto 2
Man 1
Man 2
Close Pb
Close on Panel

Normal: Warning

Encoder Low Battery
Module D Loop Open
Module D Loop Short
Module D Loop Error
Module D Loop1 Open
Module D Loop1 Short
Module D Loop1 Error
Module D Loop2 Open
Module D Loop2 Short
Module D Loop2 Error
RevEdge Was Tripped

Adjustments

Door Limit Adjustments

Door limit adjustments are used to set four heights that the door opens and closes to. There are four (4) heights that the operator can set; Closed Limit, Full Open Limit, Partial Open Limit, and Break Away Reset Limit. The Closed Limit should **always** be checked for correct height or set before the other limits are set. When any limit is set all of the limits should be checked or set.

Closed Limit

Used to set the fully closed position of the door. The door controller uses this position as the “zero” position to establish the height that the door moves to for two (2) open positions and the break away position. The Open, Partial, and Break Away limits are all relative to the Closed Limit. If the closed limit is reset to a different position, all the other settings will change relative to the new Closed Limit Setting.

Full Open Limit

Used to set the height that the door opens fully to.

Partial Open Limit

Used to set the height that the door opens to if it is programmed for a lower opening in addition to the fully open position.

Periodic Maintenance Continued...

Quarterly Inspection

1. Perform daily inspection.
2. Check all mounting hardware and verify that all nuts and bolts are tight. Hardware includes: wall anchors, cover hardware, motor mounting hardware, and bearing bolt nuts.
3. Check the break away function by performing the following steps:
 - Stop the door so the bottom rail is between waist and chest high.
 - Push the bottom bar out of one of the side columns.
 - Press the open key pad and verify that the door opens to the break away opening height and that the bottom bar centers in the side rails.
 - Press the close key pad and verify that the bottom rail is centered and the door closes fully.
4. Inspect all side and top weather seals for wear or damage.

Troubleshooting

DISPLAY OR DOOR

Problem	Possible Cause	Corrective Action
No control or VFD display.	Loss of main power.	Check with meter across L1-L2,L2-L3,L1-L3
	Blown Fuse	Check with Meter: Across 1L1-1L2, 1L2-1L3,1L1-1L3 Across 2L1-2L2, 2L2-2L3, 2L1-2L3
No display or LED's light on module panel.	Loss of power.	Check with meter across 1L1-1L2 at control transformer.
	Blown fuse.	Use meter to check for 24V between wired H_ terminals on top of transformer and between XF and X2 on bottom of transformer.
	E stop jumper loose or missing.	Verify that jumper is between 1A and 1B on terminal strip of module board.
	If E stop button present.	Check to see if E stop button activated.
Door will not open.	No input signal at module A	Check activation input by pressing corresponding test button, LED should light and door open. If door opens: faulty activator or wiring to module. If door does not open by test button: faulty module.

Trouble Shooting Continued...**DISPLAY OR DOOR**

Problem	Possible Cause	Corrective Action
Door does not close.	Held open by safety input or activator input.	Check display readout. Check for lit LED on modules A and B. Remove corresponding wire on module A. For lit LED-if door closes: faulty activator. If LED stays lit and door stays open: faulty module.
		Held open if loop installed. Check loop module for lit LED. Remove loop wires from module terminal strip. If door closes: faulty loop wire. If door remains open and LED stays lit after removal of loop wires: faulty module.
	Reversing edge activated.	Check display reset. Check for bad wire connection. Check that edge is not pinched.
	Breakaway activated.	Check display reset. Check for bad wire connection. Check that edge is not pinched.
Door does not open or close.	Brake not disengaging.	Check power at terminals 5 and 6 below module C for 24 VAC. Check power at terminals B1 and B2 for 3 phase power.
	No encoder change, no position change.	Door jammed: clear jam Broken drive shaft. Call manufacturer.
	Encoder com loss of signal.	Check for loose connections or broken cable. Check for encoder mounting. Call manufacturer.

Trouble Shooting Continued...

Light Curtain

Problem	Possible Cause	Corrective Action
Red alarm LED on.	Transmitter disabled no synchronization signal.	Check power supply and cable green LED should be on at all times.
Yellow LED flashing.	Sever electrical interference.	Remove cables from high voltage.
	High ambient light.	Check and adjust alignment of transmitter and receiver.
Yellow LED always off.	Receiver cannot see transmitter.	Remove obstruction.
No green LED.	Loss of 24 VDC	Check across terminal 1 and 4 on module B: Remove wires from terminal 1, 2, 3, 4. If 24 VDC present at terminal 1 and 4: isolate faulty light curtain. If 24 VDC not present at terminal 1 and 4 after removal of wires: faulty module.

Motor Drive Fault

To clear a fault press the stop key, or cycle power.

Problem	Possible Cause	Corrective Action
Motor drive fault	F3 power loss.	Check incoming power.
	F4 undervoltage.	Check incoming power for low voltage or power interruptions.
	F5 overvoltage	Check for incoming power.
	F6 motor stalled.	Increase accel time or reduce load so drive does not exceed set current in A089.
	F8 heatsink overheat.	Check for blocked or dirty heat sink fins, check fan.
	F13 ground fault.	Check the motor and external wiring for the drive output terminals for a grounded condition.

Trouble Shooting Continued...**Motor Drive Fault**

Problem	Possible Cause	Corrective Action
Motor Drive Fault	F38 phase U to ground.	Check wiring between drive and motor. Check motor grounded phase. Contact manufacturer.
	F39 phase V to ground.	
	F40 phase W to ground.	
	F41 phase UV short.	Check the motor and drive output terminal wiring for shorted condition. Contact manufacturer.
	F42 phase UW short.	
	F43 phase VW short.	
F70 power unit.	Recycle power. If fault does not clear, call manufacturer.	

MOTOR WIRING

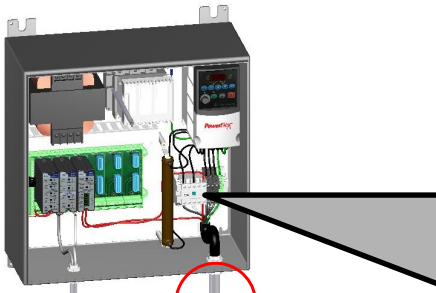

MOTOR WIRE CONDUIT

DRILL ONLY INTO BOTTOM OF BOX
1 G9A-B-A1A 17CB81 #

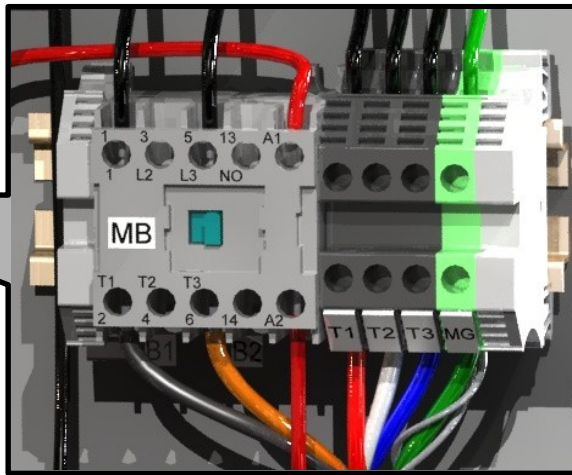

	WIRE	TO TERMINAL
SEPARATE FOIL SHIELD	RED	T1
	WHITE	T2
	BLUE	T3
	GREEN	MG
	BARE SHIELD DRAIN	MG
SEPARATE FOIL SHIELD	BLACK	B1
	ORANGE	B2
	BARE SHIELD DRAIN	MG

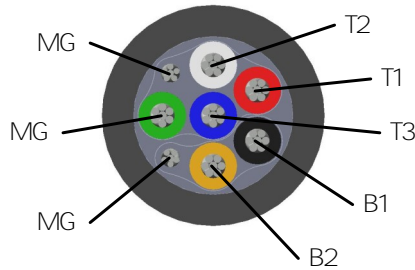

NOTE: TO CHANGE DIRECTION OF MOTOR ROTATION . SWITCH T1 AND T2

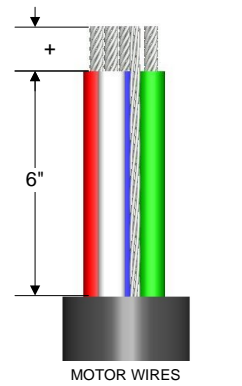
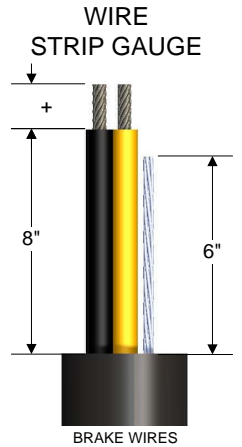

ENCODER WIRING

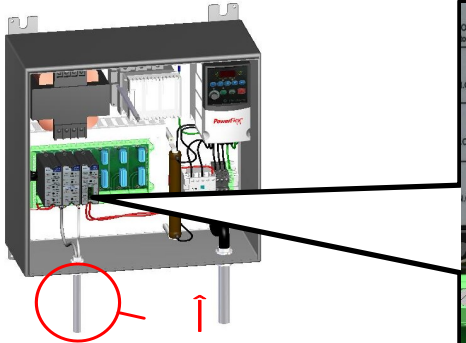

LOW VOLTAGE CONDUIT
ENCODER, SAFETY, ACTIVATION

DRILL ONLY INTO BOTTOM OF
BOX
1 G9A-B-A1A 17CB81 #

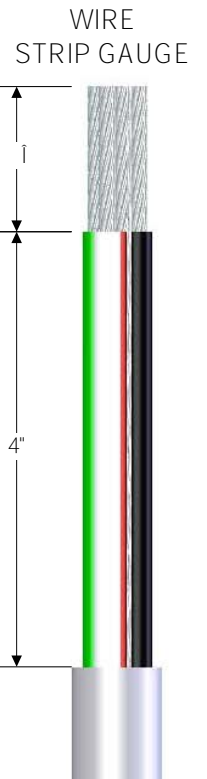
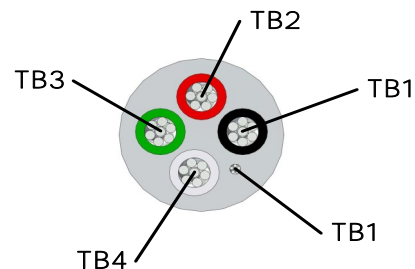
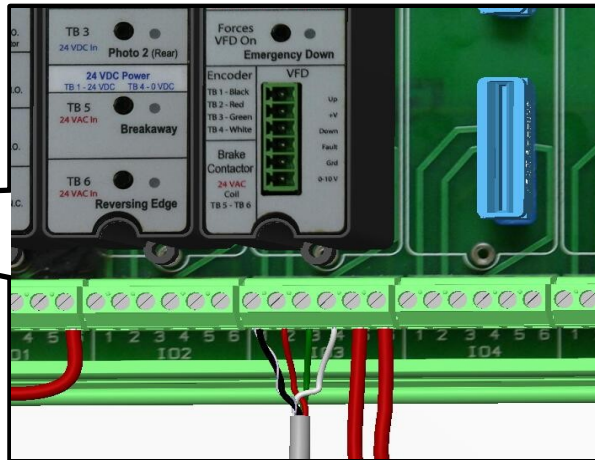

ACTIVATION WIRING

N TOP 3 TERMINALS
H NEXT 5 TERMINALS

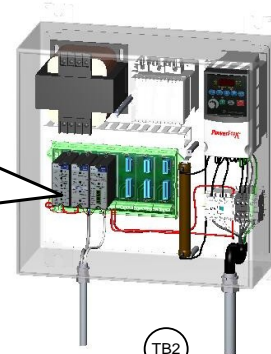
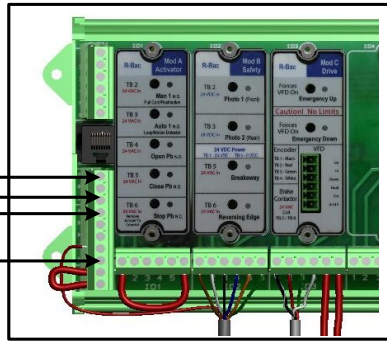

MANUAL
ACTIVATORS

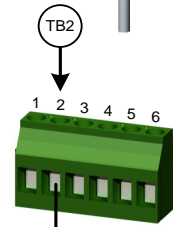

MODULE - A



MOTION SENSOR

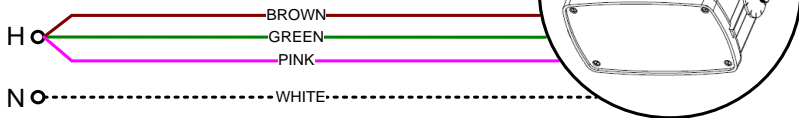

Connect GRAY for Person Detection
Connect RED for Vehicle Detection

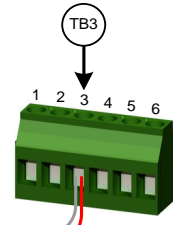

MODULE - A



MOTION SENSOR

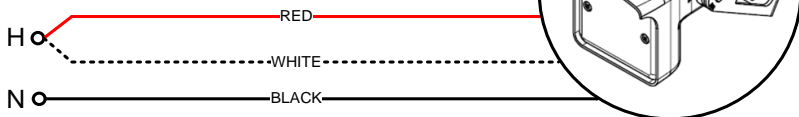

GREEN

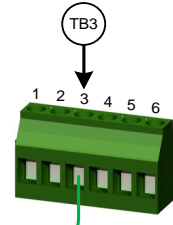

MODULE - A



REMOTE
CONTROL

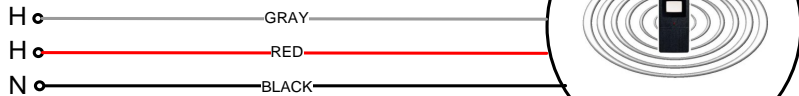

GRAY

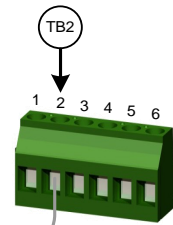

MODULE - A



LOOP DETECTOR

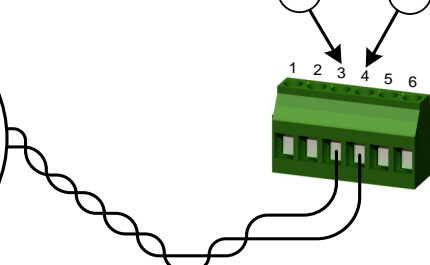
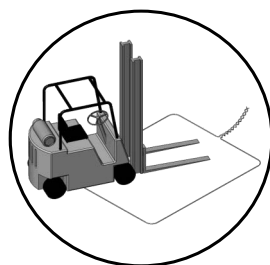

MODULE - D



(optional)

ENABLING THE WIRELESS SAFETY SYSTEM

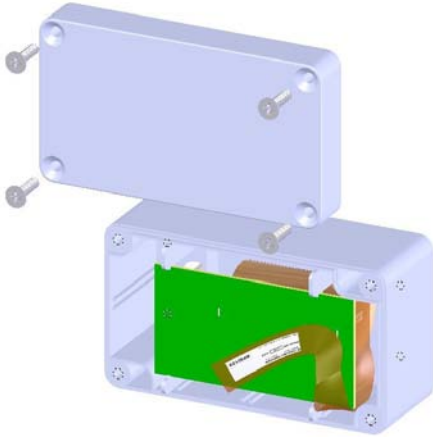

If the door is equipped with Albany's Wireless Safety System (indicated by the lack of a coil cord), the following steps must be taken to initialize the communications:







1. Locate the RF transceiver on the bottom slat (shown to left)
2. Remove the cover and locate the RFID number on the pull strip.
3. Setup the UltraSmart™ Controller according to the procedure below:
4. Hold the circuit board with one hand and pull out the strip.
5. Replace the cover and 4 screws.
6. Test the system.



UltraSmart™ Controller Settings

Press and hold  until "LIMIT SETUP" is shown on the display

Press  until "WIRELESS SETUP" is shown; Press 

Press  until "BOTTOM BAR ID" is shown; Press 

Change the number to the RFID number on the bottom bar label using  and 

Press  to store the value and press  until "DOOR READY" is displayed

Thoroughly test the system to determine if all sensors/switches are functioning properly. Make sure you can answer "yes" to the following questions:

- Does the door reverse when the reversing edge is tripped upon closing?

If you cannot answer "yes" to all the above questions, check all wiring connections and ensure the RFID is set to the same number that is labeled on the wireless bottom bar module.

UltraSmart™ STARTUP PROCEDURE

















Albany's UltraSmart™ control system is designed to accommodate numerous option modules and future technological advances. This manual will address necessary settings for the standard options; however, optional modules and special applications may require additional steps to be taken for proper setup. Refer to the control schematic shipped inside the panel enclosure for additional electrical and setup details.



SETTING DOOR LIMITS

NOTE: SAFETY DEVICES WILL PREVENT THE DOOR FROM CLOSING IF ACTIVATED DURING SETUP











ENABLE THE WIRELESS SYSTEM (IF EQUIPPED) PRIOR TO SETTING DOOR LIMITS

- 1) Press and hold  until "LIMIT SETUP" is shown on the display; Press 
- 2) "CLOSED LIMIT" should be displayed; Press 
- 3) Use  and/or  to bring the door to the full closed position; Press 
- 4) Press  "FULL OPEN LIMIT" should be displayed; Press 
- 5) Use  and/or  to bring the door to the full open position; Press 
- 6) Press  "PARTIAL OPEN LIMIT" should be displayed; Press 
- 7) Use  and/or  to bring the door to the partial open position or set the same as the full open position if not used; Press 
- 8) Press  until "DOOR READY" is displayed











CAUTION

The *Open* and *Partial Limits* are all relative to the *Closed Limit*. If the *Closed Limit* is reset to a different position, all other limit settings will change relative to the new *Closed Limit* setting.

SETTING SYSTEM OPTIONS

- 1) Press and hold  until "LIMIT SETUP" is shown on the display; Press 
- 2) Press  until "SYSTEM OPTIONS" is shown; Press 
 - ⇒ Use  and/or  to cycle through the available options; Press  to edit that option.
 - ⇒ Use  and/or  to change the value; Press  to store that value
- 3) When finished—press  until "DOOR READY" is displayed

SETTING TIMERS

- 1) Press and hold  until "LIMIT SETUP" is shown on the display; Press 
- 2) Press  until "SET TIMERS" is shown; Press 
 - ⇒ Use  and/or  to cycle through the available options; Press  to edit an option.
 - ⇒ Use  and/or  to change the value; Press  to store that value
- 3) When finished—press  until "DOOR READY" is displayed

Instructions for Using Over-Travel Brake System.



About the Over-Travel Brake System

Your UltraSecure door is fitted with an over-travel brake system to stop your door in a controlled manner in the event a condition should arise leading to the door traveling past its upper limits. The system terminates the open command and immediately engages the gear motor brake. But, due to the high rotational inertia of the barrel, an additional mechanical brake is utilized, catching the bottom slat for a controlled deceleration. This addendum shows how to reset the system to get your door operational. Prior to resetting the brake, you must lower the door to the open position. Follow electrical instructions for lowering process.

Notice: Inspect the door for damage prior to putting it back in service. Repair door where necessary. Failure to perform inspections and repairs can lead to personal injury, property damage or death.

If an over-travel event occurs, hooks mounted on the bottom slat engage the brake yoke. The yoke is then dragged through the pair of brake clamps finally coming to rest at the end of the clamp (fig 2.).



Fig 2. Safety brake deployed.

Resetting the Brake

To reset the brake, first loosen the clamp screws (Fig 3) so that you can move the yoke up and down easily.

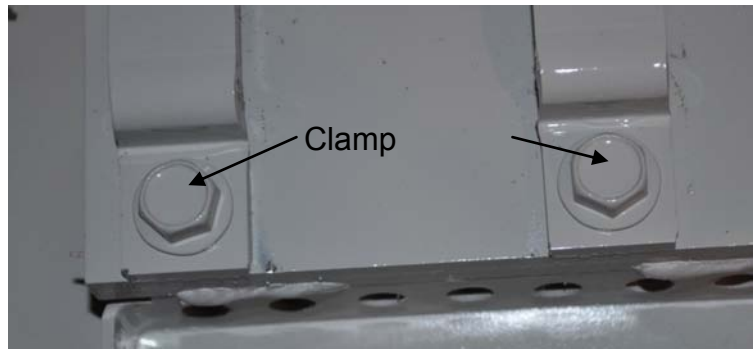

Fig 3.



Fig 4. Yoke at bottom position.

Move the yoke to the bottom of the clamp and retighten clamp



Rotate yoke rest to a horizontal position and snap yoke into pocket.

Reset door limits.
Your door is now ready to go back into service.



















Electrical Operation Instructions

When the over-travel mechanism has been engaged, the power to the control system will be disabled. The following procedure will reset the electrical system:

1. Turn the power off (wait 20 seconds) and then back on using the main panel disconnect switch.
2. With the power on, open the control panel and locate the over-travel sensor relay (shown here with teal override button).
3. Press and hold the teal override switch on the sensor relay and jog the door down using the “Emergency Jog Down” button on the face of the C-Module.
4. Once the door has been lowered below the normal open position, stop.
5. Reset the door limits as follows:



- 1) Press and hold  until “LIMIT SETUP” is shown on the display; Press 
- 2) “CLOSED LIMIT” should be displayed; Press 
- 3) Use  and/or  to bring the door to the full closed position; Press 
- 4) Press  “FULL OPEN LIMIT” should be displayed; Press 
- 5) Use  and/or  to bring the door to the full open position; Press 
- 6) Press  “PARTIAL OPEN LIMIT” should be displayed; Press 
- 7) Use  and/or  to bring the door to the partial open position or set the same as the full open position if not used; Press 
- 8) Press  until “DOOR READY” is displayed

High Speed Doors Operation

RR 3000, 2



Pos. Item	Description	Bemerkung Note	gültig ab ▶ gültig bis valid from ▶ valid to	Art.-Nr. Item-No	Delivery time class	ALBANY DOOR SYSTEMS		Anzahl pro Tor Quantity per door	Verschleißteil part / Slidetail
							Einheit Unit		
1	Side frame right Side frame left (mirror image)								
1	Column RH cpl			8220RG215	C		Stck./pc.	1	
	Column LH cpl			8220RG216	C		Stck./pc.	1	
2	Guide cover top RH			4521RG151	B		Stck./pc.	1	
	Guide cover top LH			4521RG152	B		Stck./pc.	1	
3	Guide cover bottom RH			4521R1101	B		Stck./pc.	1	
	Guide cover bottom LH			4521R1102	B		Stck./pc.	1	
4	Corner plate top RH			4521RG149	B		Stck./pc.	1	
	Corner plate top LH			4521RG150	B		Stck./pc.	1	
5	Corner plate bottom RH			4521R1099	B		Stck./pc.	1	
	Corner plate bottom LH			4521R1100	B		Stck./pc.	1	
6	Spring cover top			4521R0957	B		Stck./pc.	2	
7	Spring cover middle			4521RG109	B		Stck./pc.	2	
8	Spring cover bottom (side of bearing)	H>3000		4521R0974	B		Stck./pc.	1	
	Spring cover bottom (side of bearing)	H<=3000		4521RG111	B		Stck./pc.	1	
	Spring cover bottom RH (side of unit)	H>3000		4521R0972	B		Stck./pc.	1	
	Spring cover bottom LH (side of unit)	H>3000		4521R0973	B		Stck./pc.	1	
	Spring cover bottom RH (side of unit)	H<=3000		4521RG113	B		Stck./pc.	1	
	Spring cover bottom LH (side of unit)	H<=3000		4521RG115	B		Stck./pc.	1	
9	Tension spring short L=976mm	H<3000		4802R0009	A		Stck./pc.	max 12	X
	Tension spring middle L=1397mm	3000<=H<4000		4802R0007	A		Stck./pc.	max 12	X
	Tension spring long L=2193mm	H>=4000		4802R0008	A		Stck./pc.	max 12	X
10	Spring suspension top cpl			8220R0050	A		Stck./pc.	4	
11	Belt (blue)	L=3600		5105R0045	A		m	4 pc	
12	Rubber cable curtain tension	L=(H-200)x0,6		5105R0009	A		mm	8 pc	
13	Redirection rope with cable			8120RG046	A		Stck./pc.	2	
14	Rope for curtain tension	L=H+940		5105R0037	A		mm	2 pc	
15	Emergency lever			8220RG218	A		Stck./pc.	1	
15	Bowdenhelix d=2,5	L=800		5006R0006	A		mm	1	
17	Brake lever			5006R0023	A		Stck./pc.	1	
18	Bowdencable d=1,5	L=H+500		5006R0007	A		mm	1	
19	Bottomplate RH			4521R1064	A		Stck./pc.	1	
	Bottomplate LH			4521R1065	A		Stck./pc.	1	
20	Cable Chain cpl	(*)		8520RG002	A		Stck./pc.	2	
21	Belt receptacle			8120R0047	A		Stck./pc.	2	
22	Proximity switch M8 10E Plugconnector			4905R0062	A		Stck./pc.	1	
23	Photocell transmitter	Seitenell re		4904R0211	A		Stck./pc.	1	
	Photocell receiver	Seitenell ll		4904R0283	A		Stck./pc.	1	
24	Cable Duct cpl	L=2000		8120R0049	A		Stck./pc.	4	
25	Spring Suspension			4521R1090	A		Stck./pc.	6	
26	Sliding rail			4101R0006	A		m	24	
27	Rope pulley			5003R0001	A		Stck./pc.	8	
28	Choice label emergency lever			8020R0004	A		Stck./pc.	1	
29	Door label			5404R0004	A		Stck./pc.	1	

(*)

RR 3000, 2



Pos. Item	Description	Bemerkung Note	gültig ab ▶ gültig bis valid from ▶ valid to	Art.-Nr. Item-No	Delivery time class	Einheit Unit		Anzahl pro Tor Quantity per door	Verschleißteil part / Stützteile
II	Panel Door Blade Type 1								
1	Top lamella, with Intel sealing			8230RG032	A		m	1	
2	Lamella 1 with extension piece 1 - short			8230RG029	A		m	max 10	
3	Lamella 2 with extension piece 2 - middle			8230RG030	A		m	max 13	
4	Lamella 3 with extension piece 3 - long	H>3125		8230RG031	A		m	max 15	
5	Windowlamella 1 with extension piece 1 - short			8230RG033	A		m	max 8	
6	Windowlamella 2 with extension piece 2 - middle			8230RG034	A		m	max 8	
7	Windowlamella 3 with extension piece 3 - long	H>3125		8230RG035	A		m	max 10	
8	Bottom lamella with rubber profile, without extension piece 4			8230RG036	A		m	1	
9	Extension piece 1, short			4521R0877	A		Stück./pc.	max 22	
10	Extension piece 2, middle			4521R0878	A		Stück./pc.	max 26	
11	Extension piece 3, long			4521R0879	A		Stück./pc.	max 30	
12	Extension piece 4 re, for bottom lamella			8150R0064	A		Stück./pc.	1	
13	Extension piece 4 ll, for bottom lamella			8150R0065	A		Stück./pc.	1	
14	Clamping lug standard			4521R0966	A		Stück./pc.	max 78	
15	Clamping lug bracket 4	H>3250		4521R1028	A		Stück./pc.	max 2	
16	Connecting lug bracket 4	H<=3250		4521R1069	A		Stück./pc.	max 2	
17	Lamella sealing			4401R0014	A		m	200	
18	Sealing top lamella			4421RG011	A		m	6	
19	Bottom rubber profile			4401R0015	A		m	6	
20	Flat belt	L = H + 940		5105R0038	A		m	12	
21	Photozell transmitter RH	Vari. LS II		4904R0211	A		Stück./pc.	1	
	Photozell receiver LH	Vari. LS re		4904R0283	A		Stück./pc.	1	
22	Bracket pre running photocell RH			4521R0943	A		Stück./pc.	1	
	Bracket pre running photocell LH			4521R1023	A		Stück./pc.	1	
23	Activator Proximity switch RH			4521R0981	A		Stück./pc.	1	
	Activator Proximity switch LH			4521R0982	A		Stück./pc.	1	

High Speed Doors Operation



RR 3000, 2

Pos. item	Description	Bemerkung Note	Art.-Nr. Item-No	Delivery time class	Einheit Unit	Anzahl pro Tor Quantity per door	Wear part / Stichtaste
III	Barrel cpl						
	Barrel cpl	H<=3250	8240RG100	C	Stck./pc.	1	
	Barrel cpl	H>3250	8240RG100	C	Stck./pc.	1	
1	Spiral disk 1		4521R0940	A	Stck./pc.	2	
2	Spiral disk 2		4521R0939	A	Stck./pc.	2	
3	Spiral disk 3 LH	H>3250	4521R1048	A	Stck./pc.	1	
	Spiral disk 3 RH	H>3250	4521R1047	A	Stck./pc.	1	
4	Dampener disks	L=1850	4401R0002	A	m	10	
5	Bearing d 35		8140R0050	A	Stck./pc.	2	
6	Brecket belt		4521R0953	A	Stck./pc.	2	
7	Winding plate		4521R0941	A	Stck./pc.	2	
8	U-Brecket		4521R0985	A	Stck./pc.	max 12	
9	Brecket cam		4521R0928	A	Stck./pc.	max 12	
10	Barrel without components		4521RG103	C	Stck./pc.	1	

RR 3000, 2



Pos. Item	Description	Bemerkung Note	gültig ab valid from	gültig bis valid to	Art.-Nr. Item-No	Delivery time class	Einhelt Unit		Anzahl pro Tor Quantity per door	Wear verschleißteil part / Stückerls
IV	Drive unit cpl									
1	Gear motor 220-230 / 400-415 V 50 Hz - ACS 50	H>4000			6601R0063	A		Stck./pc.	1	
	Gear motor 220-230 / 400-415 V 60 Hz - ACS 50	H<=4000			6601R0010	A		Stck./pc.	1	
2	Brake 15Nm 180V DC HL				6622R0018	A		Stck./pc.	1	
3	Double Proximity switch				4905R0019	A		Stck./pc.	1	
4	Torque Arm				4521R0776	A		Stck./pc.	1	
5	Spindle-limit-switch cpl. for drive unit standard				4521R1096	B		Stck./pc.	1	
6	Spindle-limit-switch				5004R0041	A		Stck./pc.	2	
7	Microswitch				6621R0002	B		Stck./pc.	1	
8	Spring 2,2x11x48				4802R0004	A		Stck./pc.	1	
9	No.-cable 4x1,5				4907R0020	A		mm	1 pc	
10	Cable 2x0,75				4907R0018	A		mm	1 pc	
11	Cable 4x0,25 11,5m GY	5m<SL<=10m			4907R0026	A		Stck./pc.	1	
	Cable 4x0,25 21,5m GY	10m<SL<=20m			4907R0027	A		Stck./pc.	1	
	Cable 4x0,25 31,5m GY	20m<SL<=30m			4907R0028	A		Stck./pc.	1	
	Cable 4x0,25 6,5m GY	SL<=5m			4907R0025	A		Stck./pc.	1	
12	Junctionbox Splug 11,5m cable	5m<SL<=10m			4906R0028	A		Stck./pc.	1	
	Junctionbox Splug 21,5m cable	10m<SL<=20m			4906R0029	A		Stck./pc.	1	
	Junctionbox Splug 31,5m cable	20m<SL<=30m			4906R0030	A		Stck./pc.	1	
	Junctionbox Splug 6,5m cable	SL<=5m			4906R0027	A		Stck./pc.	1	

Legend	
1	
S	No automatic price calculation
Delivery time	
A	Within 24 hours
B	2-3 Workdays
C	5-8 Workdays
D	10-14 Workdays
Wear parts	
x	Standard wear with time/use

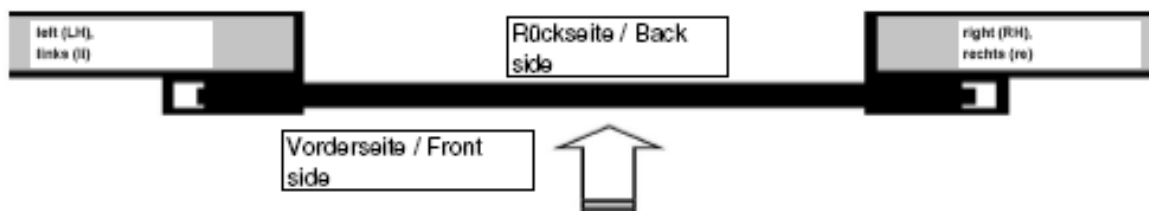



1080 Maritime Drive, Port Washington, WI 53074
Phone: (262) 268-9885 Fax: (262) 268-9895
albanydoors.com
